

SEMITOP[®] 3

IGBT Module

SK25GD126ET

Preliminary Data

Features

- Compact design
- One screw mounting
- Heat transfer and isolation through direct copper bonded aluminium oxide ceramic (DCB)
- Ultrafast NPT technology IGBT
- CAL technology FWD
- Integrated NTC temperature sensor

Typical Applications

- Inverter

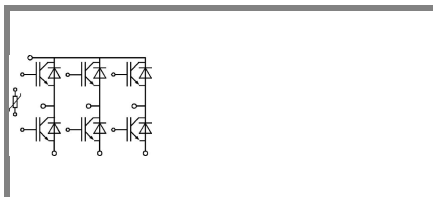

GD-ET

Absolute Maximum Ratings		$T_s = 25\text{ °C}$, unless otherwise specified			
Symbol	Conditions	Values			Units
IGBT					
V_{CES}	$T_j = 25\text{ °C}$	1200			V
I_C	$T_j = 150\text{ °C}$	$T_s = 25\text{ °C}$	32		A
		$T_s = 80\text{ °C}$	23		A
I_{CRM}	$I_{CRM} = 2 \times I_{Cnom}$	50			A
V_{GES}		± 20			V
t_{psc}	$V_{CC} = 600\text{ V}; V_{GE} \leq 20\text{ V}; T_j = 125\text{ °C}$ $V_{CES} < 1200\text{ V}$	10			µs
Inverse Diode					
I_F	$T_j = 150\text{ °C}$	$T_s = 25\text{ °C}$	28		A
		$T_s = 80\text{ °C}$	19		A
I_{FRM}	$I_{FRM} = 2 \times I_{Fnom}$	50			A
Module					
$I_{t(RMS)}$					A
T_{vj}		-40 ... +150			°C
T_{stg}		-40 ... +125			°C
V_{isol}	AC, 1 min.	2500			V

Characteristics		$T_s = 25\text{ °C}$, unless otherwise specified			
Symbol	Conditions	min.	typ.	max.	Units
IGBT					
$V_{GE(th)}$	$V_{GE} = V_{CE}, I_C = 1\text{ mA}$	5	5,8	6,5	V
I_{CES}	$V_{GE} = 0\text{ V}, V_{CE} = V_{CES}$	$T_j = 25\text{ °C}$	0,15		mA
		$T_j = 125\text{ °C}$			mA
I_{GES}	$V_{CE} = 0\text{ V}, V_{GE} = 20\text{ V}$	$T_j = 25\text{ °C}$	600		nA
		$T_j = 125\text{ °C}$			nA
V_{CE0}		$T_j = 25\text{ °C}$	1	1,2	V
		$T_j = 125\text{ °C}$	0,9		V
r_{CE}	$V_{GE} = 15\text{ V}$	$T_j = 25\text{ °C}$	28	36	mΩ
		$T_j = 125\text{ °C}$	44		mΩ
$V_{CE(sat)}$	$I_{Cnom} = 25\text{ A}, V_{GE} = 15\text{ V}$	$T_j = 25\text{ °C}_{chiplev.}$	1,7	2,1	V
		$T_j = 125\text{ °C}_{chiplev.}$	2,2		V
C_{ies}	$V_{CE} = 25, V_{GE} = 0\text{ V}$	$f = 1\text{ MHz}$	1,8		nF
C_{oes}			0,095		nF
C_{res}			0,082		nF
$t_{d(on)}$	$R_{Gon} = 25\text{ Ω}$	$V_{CC} = 600\text{ V}$ $I_{Cnom} = 25\text{ A}$	85		ns
t_r			30		ns
E_{on}	$R_{Goff} = 25\text{ Ω}$	$T_j = 125\text{ °C}$ $V_{GE} = \pm 15\text{ V}$	3,3		mJ
$t_{d(off)}$			430		ns
t_f			90		ns
E_{off}			3,1		mJ
$R_{th(j-s)}$	per IGBT	1,2			K/W

SK25GD126ET

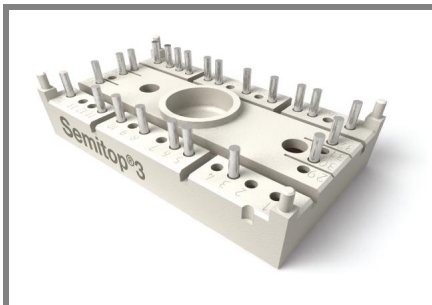

SEMITOP® 3

IGBT Module

SK25GD126ET

Preliminary Data

Features

- Compact design
- One screw mounting
- Heat transfer and isolation through direct copper bonded aluminium oxide ceramic (DCB)
- Ultrafast NPT technology IGBT
- CAL technology FWD
- Integrated NTC temperature sensor

Typical Applications

- Inverter

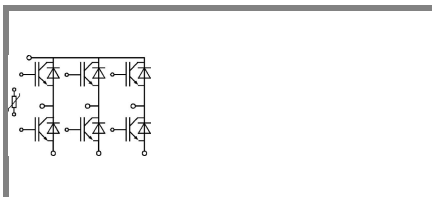

GD-ET

Characteristics			min.	typ.	max.	Units
Symbol	Conditions					
Inverse Diode						
$V_F = V_{EC}$	$I_{Fnom} = 25 \text{ A}; V_{GE} = 0 \text{ V}$	$T_j = 25 \text{ }^\circ\text{C}_{\text{chiplev.}}$		1,8		V
		$T_j = 125 \text{ }^\circ\text{C}_{\text{chiplev.}}$		1,8		V
V_{F0}		$T_j = 25 \text{ }^\circ\text{C}$		1	1,1	V
		$T_j = 125 \text{ }^\circ\text{C}$		0,8		V
r_F		$T_j = 25 \text{ }^\circ\text{C}$		32	42	mΩ
		$T_j = 125 \text{ }^\circ\text{C}$		40		mΩ
I_{RRM}	$I_{Fnom} = 25 \text{ A}$	$T_j = 125 \text{ }^\circ\text{C}$		31		A
Q_{rr}	$di/dt = -950 \text{ A}/\mu\text{s}$			5		μC
E_{rr}	$V_{CC} = 600\text{V}$			2,1		mJ
$R_{th(j-s)D}$	per diode				1,9	K/W
M_s	to heat sink		2,25		2,5	Nm
w				30		g
Temperature sensor						
R_{100}	$T_s = 100^\circ\text{C} (R_{25} = 5\text{k}\Omega)$			493±5%		Ω

This is an electrostatic discharge sensitive device (ESDS), international standard IEC 60747-1, Chapter IX.

This technical information specifies semiconductor devices but promises no characteristics. No warranty or guarantee expressed or implied is made regarding delivery, performance or suitability.

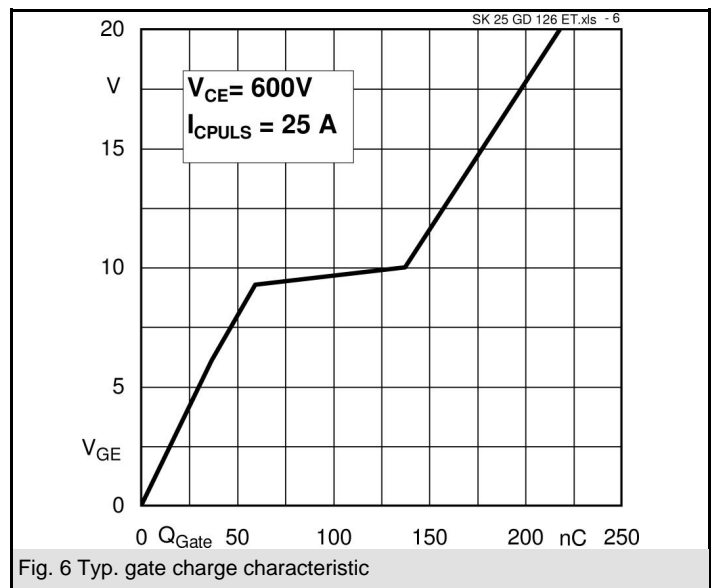
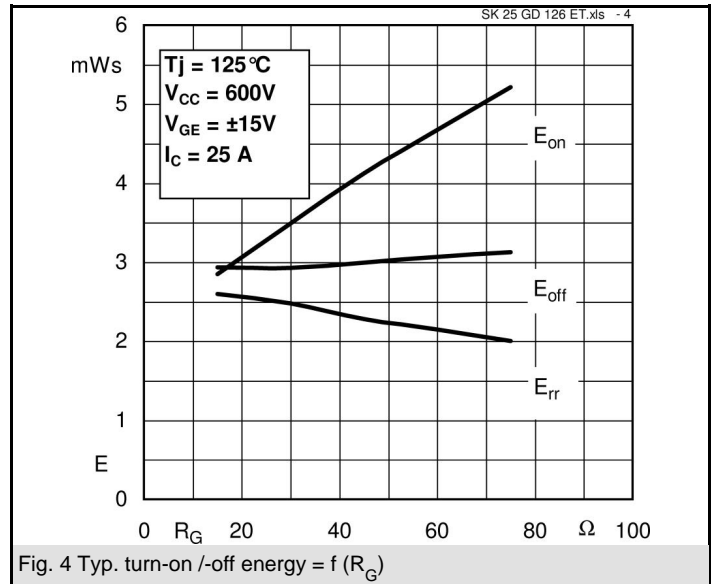
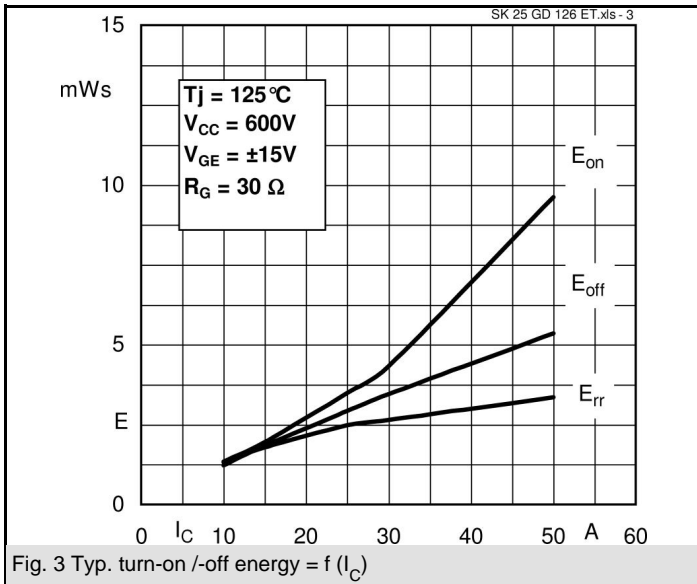
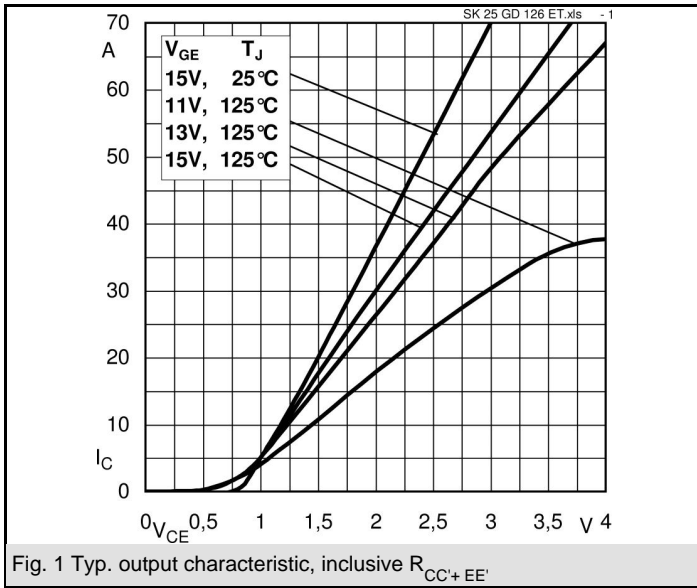

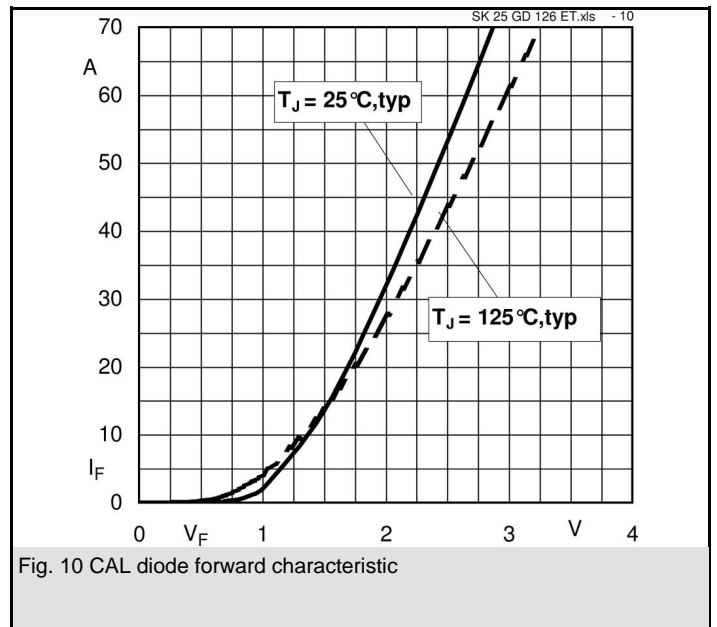
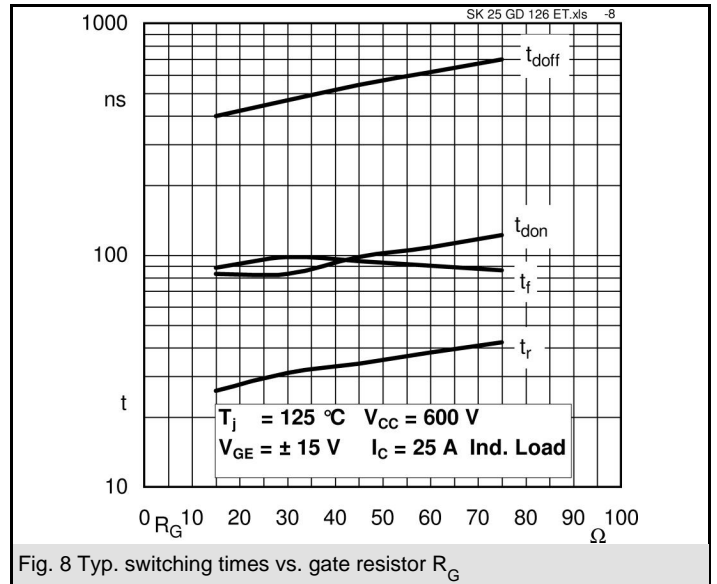
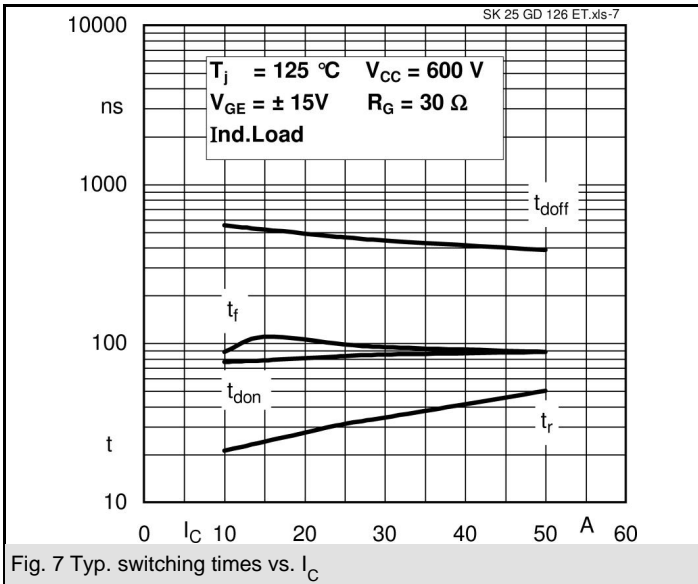

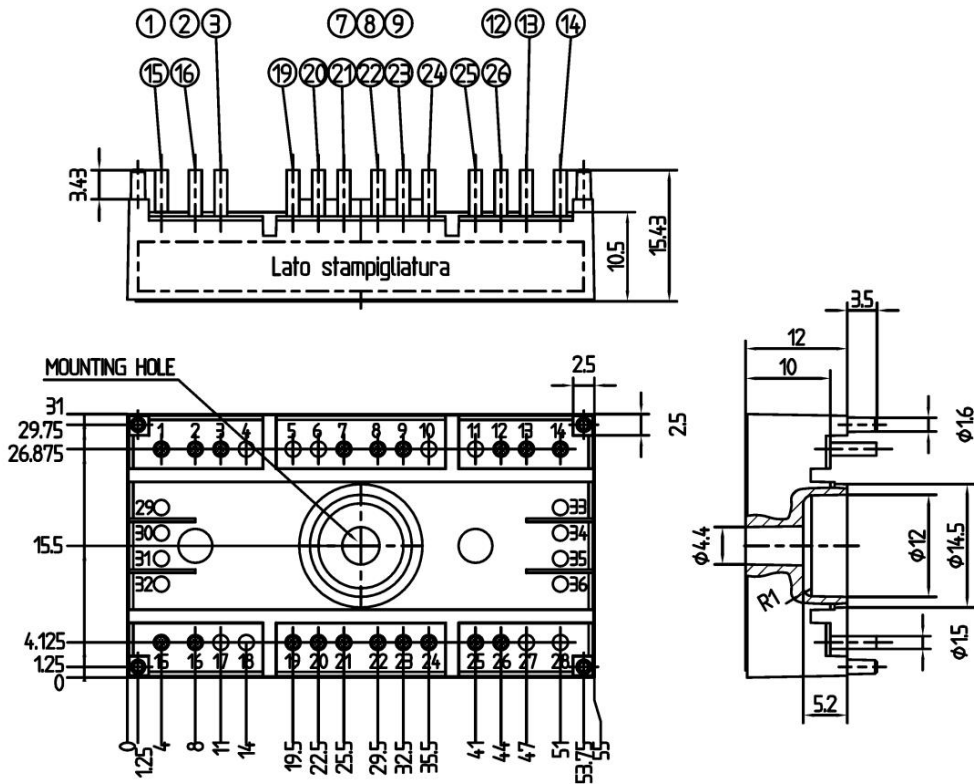

Case T52 (Suggested hole diameter, in the PCB, for solder pins and plastic mounting pins: 2mm)

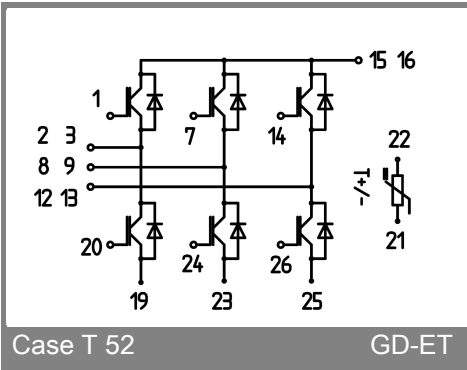

Case T 52

GD-ET